

OPI1268S

High Voltage / High Speed Opto-Isolator



Features:

- 20kV Isolation
- 30 kV/ μ S dv/dt immunity
- 2 Mbit/s transfer rate
- $t_{PHL}-t_{PLH} \leq 50$ ns typical
- Creepage path: 24 mm
- TTL Compatible
- 6 Axis / 10G_{RMS} load rating

Certifications:

- UL File # E58730
- Vde File #40031798
- IECEx BAS 11.0123u (EN60079-0:2012|EN60079-11:2012)
- IP65 Rated

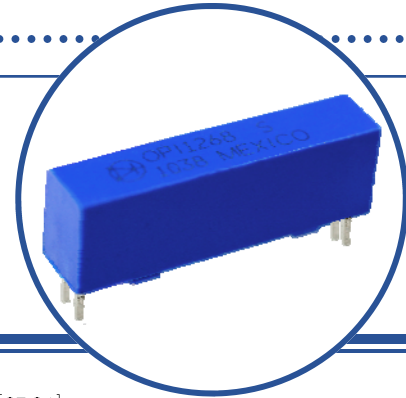

Description:

The **OPI1268S** is a high voltage isolator with a digital output that is capable of high speed data transmission. The input of the OPI1268 consists of a high-efficiency GaAIAs LED with a peak wavelength of 850 nm, which is optically coupled to the output optical IC. A photologic device in the output IC detects the incoming modulated light and converts it to a proportionate current. This current is fed into a high-gain linear amplifier which is temperature, current and voltage compensated. The result is a highly stable digital output with an open collector inverter configuration. This device produces DC and AC voltage isolation between the input and output circuitry while providing TTL signal integrity.

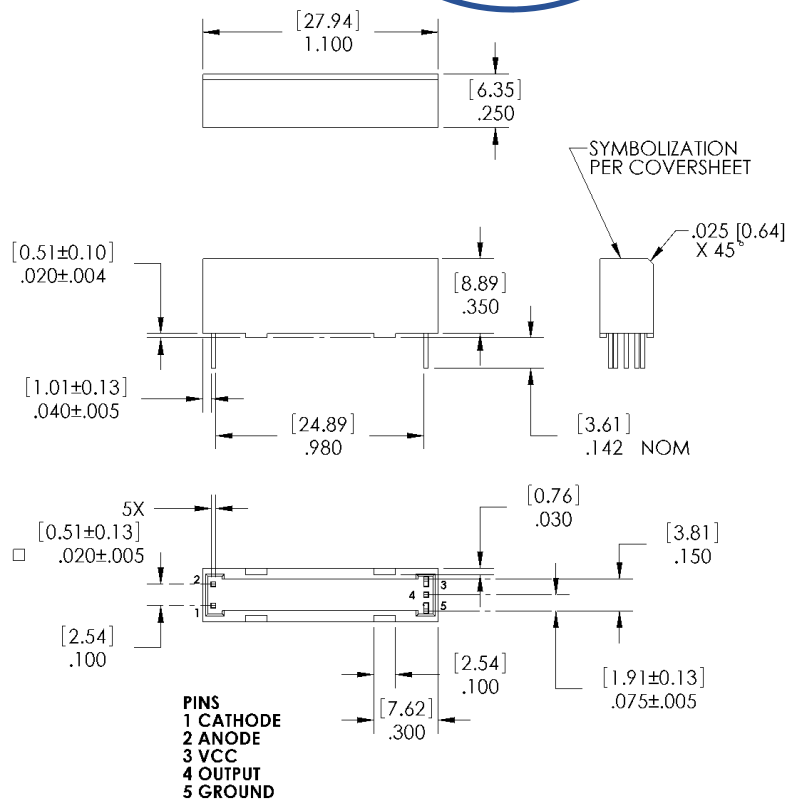

NOTE:

1. DIMENSIONS ARE $\pm .010$ [.25] UNLESS OTHERWISE NOTED.
2. DIMENSIONS ARE IN INCHES [MM].

Applications:

- Transportation Systems
- PC Board Power Systems
- Hybrid Vehicle Systems
- Medical Systems
- Control Systems

Ordering Information								
Part Number	LED Peak Wavelength	Sensor Photologic®	Isolation Voltage (kV)	t_{PLH} / t_{PHL} Max (ns)	I_F (mA) Typ / Max	V_{CE} (V) Max	Lead Length (mm)	Lead Spacing (mm)
OPI1268S	850 nm	Open Collector	20	100	10 / 50	18	3.6	2.0



RoHS

OPTEK reserves the right to make changes at any time in order to improve design and to supply the best product possible.

Absolute Maximum Ratings ($T_A = 25^\circ\text{C}$ unless otherwise noted)

Storage Temperature	-50° C to +100° C
Operating Temperature	-50° C to +100° C
Input-to-Output Isolation Voltage ⁽¹⁾⁽²⁾	20 KVDC
Lead Soldering Temperature (1/16" (1.6 mm) from case for 5 seconds with soldering iron) ⁽³⁾	260° C

Input Diode

Continuous Forward Current	30 mA
Peak Forward current (1 μs pulse width, 300 pps)	3.0 A
Reverse Voltage	3.0 V
Power Dissipation ⁽¹⁾	100 mW

Output IC

Maximum Supply Voltage	7 V
Power Dissipation ⁽¹⁾	40 mW
Maximum Output Voltage	18 V
Maximum Output Current	25 mA

Electrical Characteristics ($T_A = 0^\circ\text{C}$ to 70°C unless otherwise noted)

SYMBOL	PARAMETER	MIN	TYP	MAX	UNITS	TEST CONDITIONS
--------	-----------	-----	-----	-----	-------	-----------------

Input Diode

V_F	Forward Voltage	-	1.4	1.8	V	$I_F = 20\text{ mA}$
I_R	Reverse Current	-	0.1	100	μA	$V_R = 2.0\text{ V}$

Output IC ($V_{CC} = 4.5\text{ V}$ to 5.25 V) (See OPL550 for additional information—for reference only.)

I_{OH}	High Level Output Current	-	0.20	25	μA	$I_F = 0.0\text{ mA}$, $V_{OH} = 18.0\text{ V}$, $V_{CC} = 5.25\text{ V}$
V_{OL}	Low Level Output Voltage	-	0.35	0.55	V	$I_F = 10.0\text{ mA}$, $I_{OL} = 8.0\text{ mA}$, $V_{CC} = 4.5\text{ V}$
I_{CCH}	High Level Supply Current	-	5.5	7	mA	$I_F = 0$, $V_{CC} = 5.25\text{ V}$
I_{CCL}	Low Level Supply Current	-	7.5	10		$I_F = 10.0\text{ mA}$, $V_{CC} = 5.25\text{ V}$

Coupled Characteristics ($V_{CC} = 5\text{ V}$)

C_{IO}	Coupling Capacitance	-	-	2	pF	Input and output leads shorted.
t_{PLH}	Propagation Delay to Low Output Level	-	50	100	ns	See Figure 1
t_{PHL}	Propagation Delay to High Output Level	-	50	100		
I_{ISO}	Isolation Leakage Current	-	-	1	μA	VISO = @ 7kV RMS (input and output leads shorted)
I_{F+}	LED Positive Going Threshold Current	0.8	1.7	5.0	mA	$V_{CC} = 5\text{ V}$, $I_{OL} = 8.0\text{ mA}$
dv/dt	Voltage Spike Immunity		30		kV/ μs	

Notes:

- (1) Derate linearly 1.33 W/ $^\circ\text{C}$ above 25°C
- (2) UL registered under E58730.
- (3) RMA flux is recommended. The duration can be extended to 10 seconds maximum when flow soldering.

OPTEK reserves the right to make changes at any time in order to improve design and to supply the best product possible.

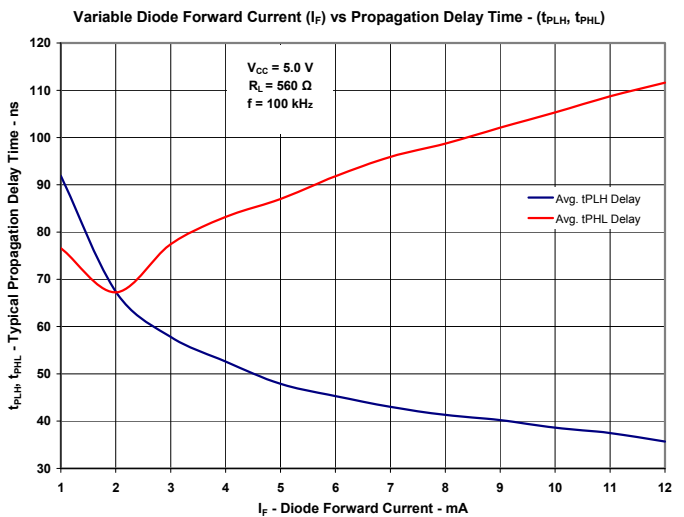
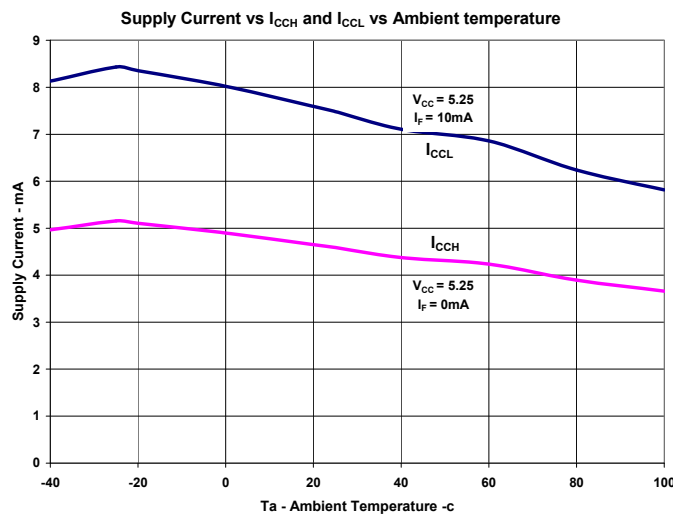
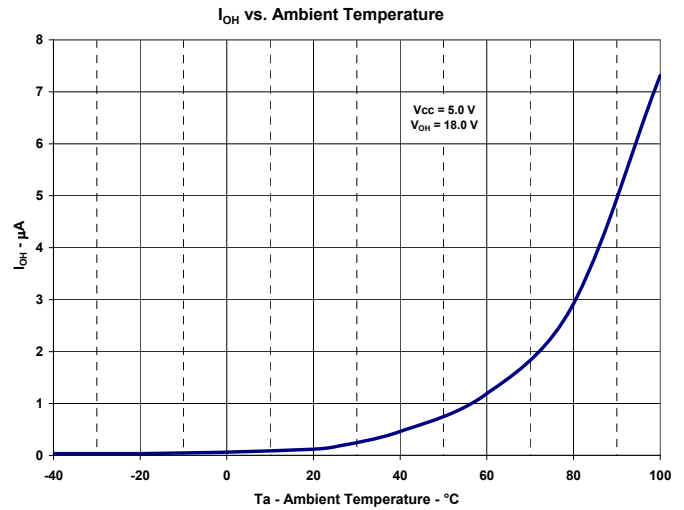
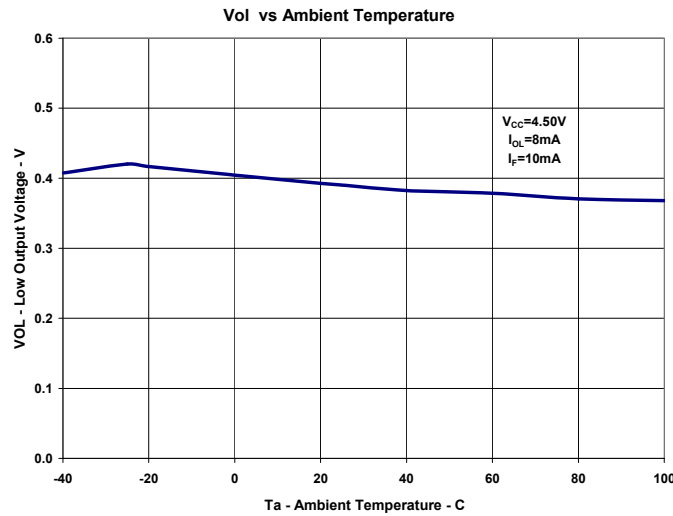
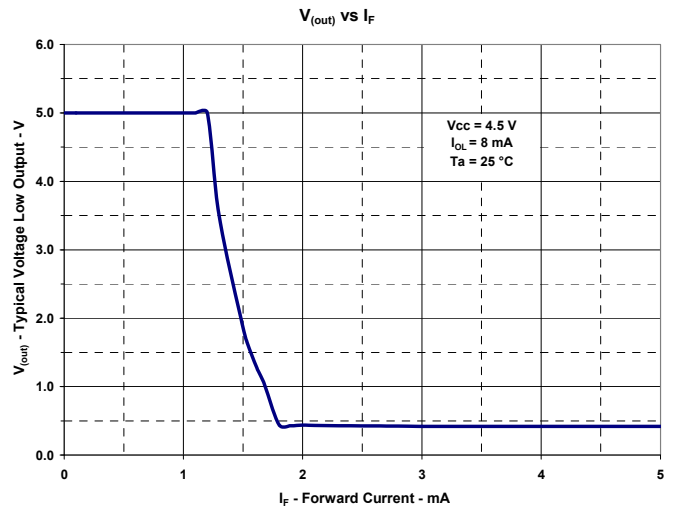
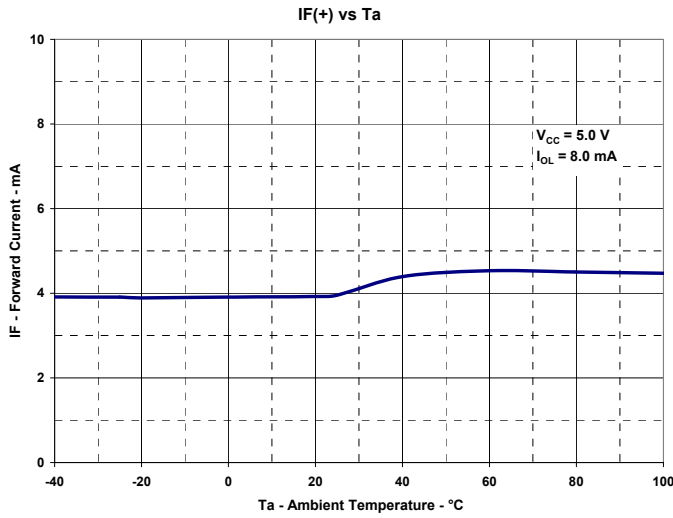

OPTEK reserves the right to make changes at any time in order to improve design and to supply the best product possible.

CIRCUIT VALUES

Condition #1: $V_{CC} = 5.0V$, $I_F = 30mA$, $R_L = 560\text{ Ohms}$

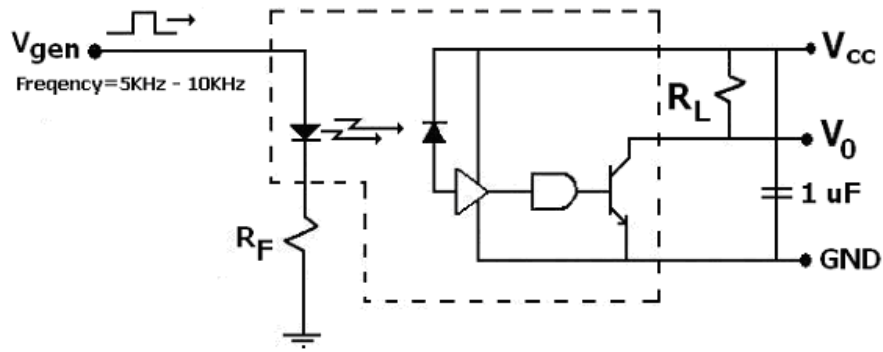
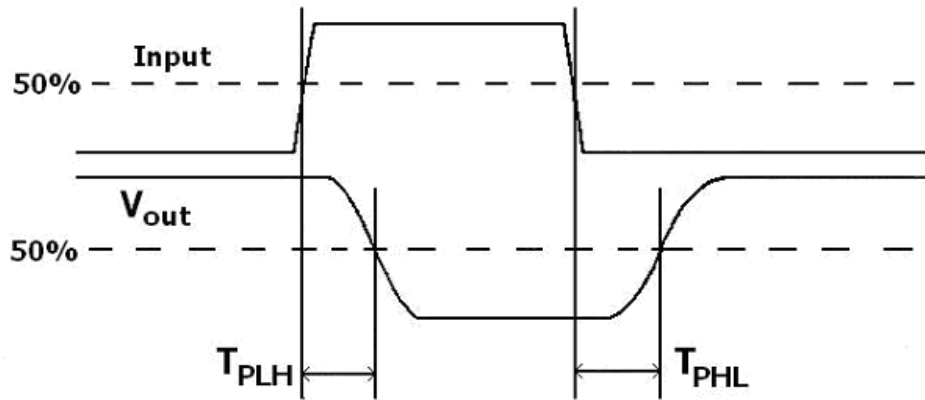

Figure 1



OPTEK reserves the right to make changes at any time in order to improve design and to supply the best product possible.

Mouser Electronics

Authorized Distributor

Click to View Pricing, Inventory, Delivery & Lifecycle Information:

[Optek:](#)

[OPI1268S](#)